

---

Operating instructions and spare parts list

# Manual powder gun

## OptiFlex 2 GM03



Translation of the original operating instructions

**Documentation OptiFlex 2 GM03**

© Copyright 2010 ITW Gema GmbH

All rights reserved.

This publication is protected by copyright. Unauthorized copying is prohibited by law. No part of this publication may be reproduced, photocopied, translated, stored on a retrieval system or transmitted in any form or by any means for any purpose, neither as a whole nor partially, without the express written consent of ITW Gema GmbH.

OptiTronic, OptiGun, EasyTronic, EasySelect, OptiFlow and SuperCorona are registered trademarks of ITW Gema GmbH

OptiMatic, OptiMove, OptiMaster, OptiPlus, PowerClean, Precise Charge Control (PCC), OptiSpray, MultiTronic and Gematic are trademarks of ITW Gema GmbH.

All other product names are trademarks or registered trademarks of their respective holders.

Reference is made in this manual to different trademarks or registered trademarks. Such references do not mean that the manufacturers concerned approve of or are bound in any form by this manual. We have endeavored to retain the preferred spelling of the trademarks, and registered trademarks of the copyright holders.

To the best of our knowledge and belief, the information contained in this publication was correct and valid on the date of publication. ITW Gema GmbH makes no representations or warranties with respect to the contents or use of this publication, and reserves the right to revise this publication and make changes to its content without prior notice.

**Printed in Switzerland**

ITW Gema GmbH  
Mövenstrasse 17  
9015 St. Gallen  
Switzerland

Phone: +41-71-313 83 00

Fax.: +41-71-313 83 83

E-Mail: [info@itwgema.ch](mailto:info@itwgema.ch)

Homepage: [www.itwgema.ch](http://www.itwgema.ch)

# Table of contents

<b>General safety regulations</b>	<b>3</b>
Safety symbols (pictograms).....	3
Conformity of use.....	3
Product-specific safety measures.....	4
OptiFlex 2 GM03 manual powder gun.....	4
<b>About this manual</b>	<b>5</b>
General information.....	5
<b>Product description</b>	<b>7</b>
Field of application.....	7
Utilization.....	7
Reasonably foreseeable misuse.....	8
Technical data.....	9
Electrical data.....	9
Dimensions.....	9
Processible powders.....	9
Design and function.....	10
General view.....	10
Operating elements.....	11
Scope of delivery.....	11
Available accessories*.....	12
PowerClean™ module.....	12
SuperCorona ring.....	13
Principle of function.....	14
High voltage generation.....	14
Circuit.....	14
Powder flow and rinsing air.....	14
Flat jet nozzle with vented central electrode.....	15
Round jet nozzle with vented deflector and vented central electrode.....	15
Typical properties - Characteristics of the functions.....	16
Remote control.....	16
Powder hose quick release connection.....	16
Connection for SuperCorona Ring.....	16
<b>Start-up</b>	<b>17</b>
Preparation for start-up.....	17
Basic conditions.....	17
Connecting the OptiFlex 2 GM03 manual powder gun.....	17
<b>Initial start-up</b>	<b>19</b>
Operation.....	20
Setting of total air.....	20
Setting the powder quantity.....	20
Setting the electrode rinsing air.....	21
Activation of the PowerClean function.....	22

Activate/deactivate the program change via remote control .....	22
<b>Cleaning and maintenance</b>	<b>23</b>
Cleaning.....	23
Cleaning the manual powder gun.....	23
Cleaning the spray nozzle .....	24
Maintenance .....	25
Replacing parts.....	25
<b>Troubleshooting</b>	<b>27</b>
General information .....	27
<b>Spare parts list</b>	<b>29</b>
Ordering spare parts.....	29
OptiFlex 2 GM03 manual powder gun - Spare parts list .....	30
Remarks .....	30
OptiFlex 2 GM03 manual powder gun - Spare parts list .....	31
PowerClean module .....	32
OptiFlex 2 GM03 manual powder gun - SuperCorona .....	33
OptiFlex 2 GM03 manual powder gun - accessories .....	34
OptiFlex 2 GM03 flat spray nozzles – overview (wearing parts).....	34
OptiFlex 2 GM03 rounded spray nozzles – overview (wearing parts) ....	35
OptiFlex 2 GM03 gun extensions and SuperCorona .....	36
OptiFlex 2 GM03 spray nozzles for extensions – overview (wearing parts)37	
Powder hoses - overview .....	38
Other accessories.....	39

# General safety regulations

This chapter sets out the fundamental safety regulations that must be followed by the user and third parties using the OptiFlex 2 GM03 manual powder gun.

These safety regulations must be read and understood in full before the OptiFlex 2 GM03 is put into operation.

---

## Safety symbols (pictograms)

The following warnings with their meanings can be found in the ITW Gema operating instructions. The general safety precautions must also be followed as well as the regulations in the operating instructions.

**DANGER!**

danger due to live electricity or moving parts. Possible consequences: death or serious injury

**WARNING!**

improper use of the equipment could damage the machine or cause it to malfunction. Possible consequences: minor injuries or damage to equipment

**INFORMATION!**

Useful tips and other information

---

## Conformity of use

1. The OptiFlex 2 GM03 is built to the latest specification and conforms to the recognized technical safety regulations and is designed for the normal application of powder coating.
2. Any other use is considered non-compliant. The manufacturer shall not be liable for damage resulting from such use; the user bears sole responsibility for such actions. ITW Gema GmbH must be consulted prior to any use of the OptiFlex 2 GM03 for any purposes or substances other than those indicated in our guidelines.
3. Observance of the operating, service and maintenance instructions specified by the manufacturer is also part of conformity of use. The OptiFlex 2 GM03 should only be used, maintained and started up by trained personnel, who are

informed about and are familiar with the possible hazards involved.

4. Start-up (i.e. the execution of intended operational tasks) is forbidden until it has been established that the OptiFlex 2 GM03 has been set up and wired according to the guidelines for machinery (2006/42 EC). EN 60204-1 (machine safety) must also be observed.
5. Unauthorized modifications to the OptiFlex 2 GM03 exempts the manufacturer from any liability from resulting damage.
6. The relevant accident prevention regulations, as well as other generally recognized safety regulations, occupational health and structural regulations are to be observed.
7. Furthermore, the country-specific safety regulations also must be observed.

---

## Product-specific safety measures

- Installation work performed by the customer must be carried out according to local regulations.
- All components must be grounded according to the local regulations before start-up.

### OptiFlex 2 GM03 manual powder gun

The OptiFlex 2 GM03 manual powder gun is a component of the system and is thus integrated into the safety system of the plant.

If it is to be used in a manner outside the scope of the safety concept, then corresponding measures must be taken.



---

#### **NOTE!**

**For further security information, see the more detailed ITW Gema safety regulations!**

---

# About this manual

---

## General information

This operating manual contains all the important information you require for the working with the OptiFlex 2 GM03 manual powder gun. It will safely guide you through the start-up process and give you references and tips for the optimal use of your new powder coating system.

Information about the function mode of the individual system components - booth, gun control unit or powder injector - should be referenced to their enclosed corresponding documents.



# Product description

---

## Field of application

The OptiFlex 2 GM03 manual powder gun is exclusively intended for electrostatic coating using organic powders. Any other use is considered non-compliant. The manufacturer is not responsible for any incorrect use and the risks associated with such actions are assumed by the user alone!



*OptiFlex 2 GM03 manual powder gun*

## Utilization

The manual powder gun type OptiFlex 2 is suited for the electrostatic coating of objects (in all shapes and geometries) that must be grounded.

**Reasonably foreseeable misuse**

- Coating of non grounded objects
- Use of enameled powder
- Incorrectly configured values for powder conveyance
- Incorrectly configured values for electrode rinsing air
- Use of moist powder

## Technical data

### Electrical data

OptiFlex 2 GM03	
Nominal input voltage	eff. 10 V
Frequency	18 kHz (average)
Nominal output voltage	100 kV
Polarity	negative (optional positive)
Max. output current	100 $\mu$ A
High voltage display	with LED
Ignition protection	Ex 2 mJ T6
Temperature range	0°C - +40°C (+32°F - +104°F)
Max. operating temperature	85°C (+185°F)
Approvals	pending



#### WARNING

The manual powder gun can be connected to OptiFlex 2, OptiStar and OptiTronic (without remote control)!

### Dimensions

OptiFlex 2 GM03	
Weight	520 g

### Processible powders

OptiFlex 2 GM03	
Plastic powder	yes
Metallic powder	yes
Enamel powder	no

## Design and function

### General view

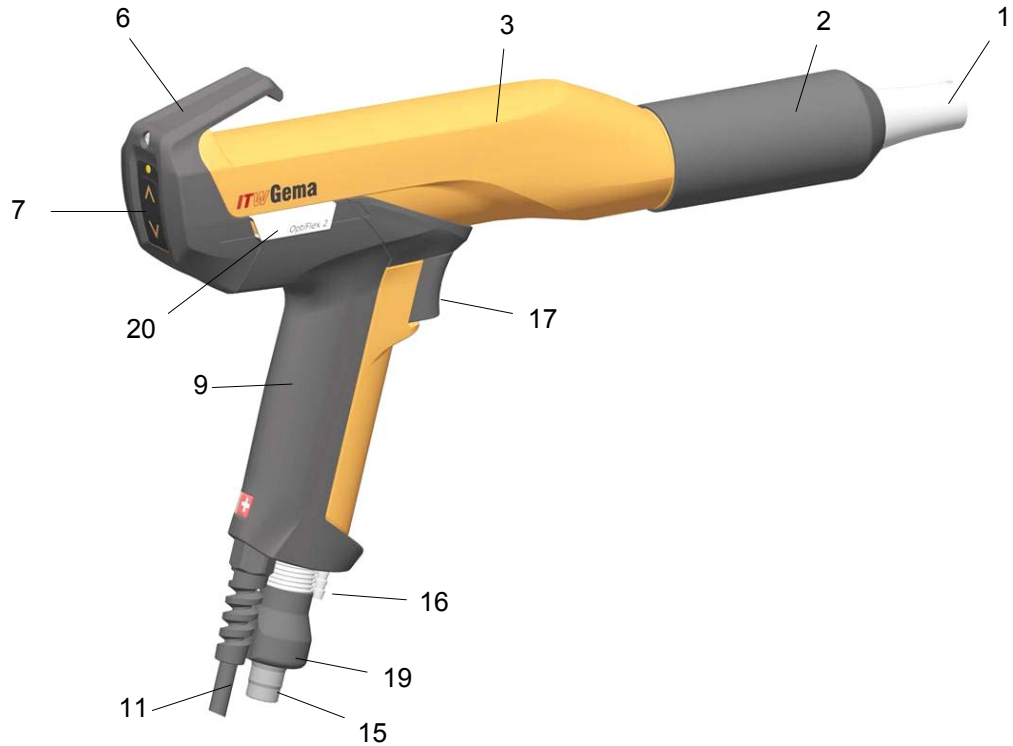

- |   |                                     |    |                                      |
|---|-------------------------------------|----|--------------------------------------|
| 1 | Spray nozzle system                 | 11 | Gun cable                            |
| 2 | Threaded sleeve                     | 15 | Powder hose connection               |
| 3 | Shaft                               | 16 | Rinsing air connection               |
| 6 | Cover with remote control and hooks | 17 | Trigger                              |
| 7 | Remote control                      | 19 | Powder hose quick release connection |
| 9 | Gun handle                          | 20 | SuperCorona - connection             |

## Operating elements

### LED and remote control buttons



### Operating elements

Designation	Function
L1	Display <b>High voltage (intensity)</b>
T1	<b>Powder output +</b> key
T2	<b>Powder output -</b> key
T3	<b>Activate/stop rinsing process</b> key

## Scope of delivery

- OptiFlex 2 GM03 manual powder gun with gun cable (6 m), negative polarity
- Powder hose (6 m, ID 10 mm)
- Rinsing air hose (6 m)
- Flat jet nozzle NF20, complete (incl. electrode holder)
- Flat jet nozzle NF21
- Cable tie with Velcro closure
- Gun cleaning brush
- Spare parts kit
- Operating manual

---

## Available accessories\*

- Rinsing module (with OptiFlex 2 CG09 manual powder gun control unit only)
- SuperCorona ring
- Flat jet nozzle (for specific applications)
- Round jet nozzles
- Gun extension 150 and 300 mm
- Gun cable extensions
- Application cup 150 and 500 ml
- Multi-spray adapter
- Various adapters for connection to earlier generations of control units
- Gloves, anti-static

\*for more information, see spare parts list

## PowerClean™ module

### *Field of application*

The PowerClean module is included with delivery of corresponding Gema devices and is only used in combination with the OptiFlex 2 CG09 control unit.

The PowerClean module provides increased stability in application processes. It prevents the bridging phenomena that can lead to short circuiting when handling powders such as metallic powders.

In moist or tropical environments, any moisture is driven from the injector, powder hose and powder gun. The color change is also accelerated during non-extreme color switches.



*PowerClean module*

## SuperCorona ring

### *Field of application*

The SuperCorona is an optional extension for the OptiFlex 2 GM03 manual powder gun, allowing for a better surface quality when coating with the powder coating equipment.

When coating wheel rims, drawers, radiators, lamps etc. the surface quality is exceptional, also in places with higher coating layer requirements. By coating with several powder types, an "orange peel" finish can be completely avoided. By coating with structure powder, the "picture frame effect" is hardly visible.

The performance of the OptiFlex 2 with SuperCorona is convincing due to its very good charging and very high deposition rate as well as an improved penetration into Faraday cages. The distance between nozzle and workpiece can be reduced to 100 mm without influencing the surface finish.



*SuperCorona - retrofit*

Due to its modular structure, the OptiFlex 2 manual powder gun can be extended quickly and easily with the lightweight SuperCorona (approx. 60 g). The OptiFlex 2 remains repair-friendly and easy to maintain even after reconfiguration.

### *SuperCorona assembly*

Before fitting the SuperCorona ring, make sure that the connection and the plug-in connector are free from grease and powder, otherwise the electric contact cannot be guaranteed.

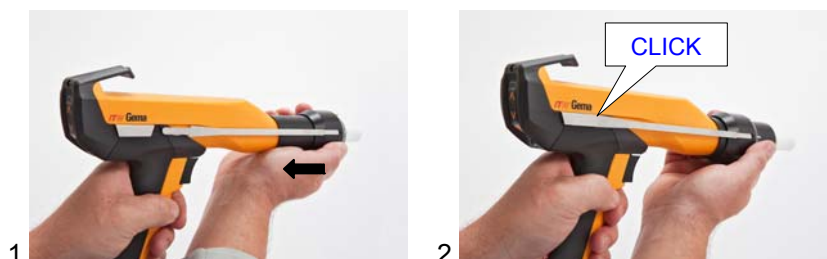

## Principle of function

### High voltage generation

The control unit supplies a high-frequency low voltage signal of approx. 10 V eff. This voltage is fed through the gun cable (11) to the high voltage cascade (4) in the gun body.

In the high voltage cascade (4), the low voltage is high-transformed in a first step (c). This primary high voltage is subsequently rectified and multiplied in the high voltage cascade in a second step (d), until the required high voltage is obtained at the end (approx. 100 kV). The high voltage is now fed to the electrode (e) within the spray nozzle.

### Circuit

In addition to the modulated low voltage needed for high voltage generation, there are signal lines fed through the gun cable. The control signals are used for monitoring gun trigger status and gun remote control functions.

The gun is released by a touch-free switch, which is operated by a magnet in the trigger (17). The gun control unit switches on the modulated low voltage, the powder transport and the rinsing air.

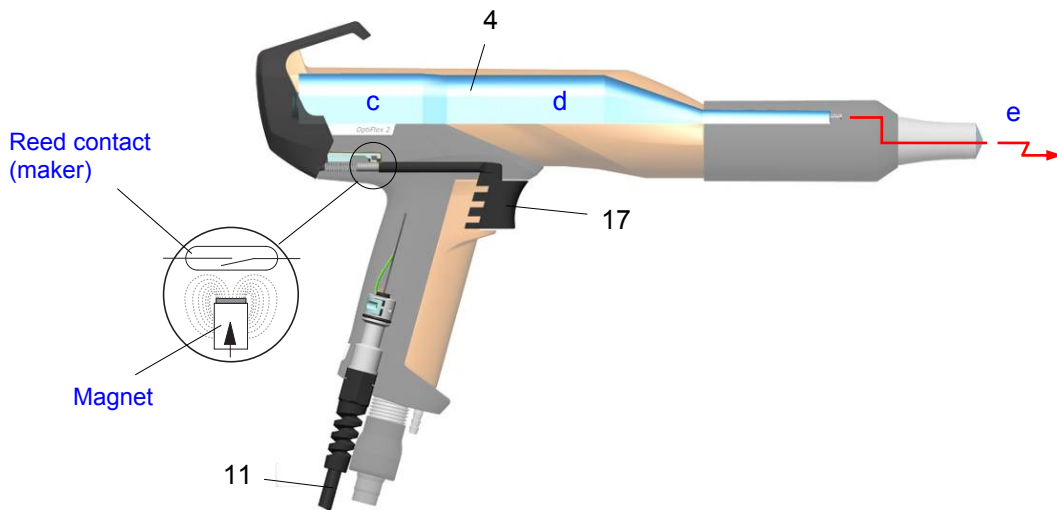

*OptiFlex 2 GM03 manual powder gun – Circuitry*

### Powder flow and rinsing air

The rinsing air is used by vented spray nozzles and is connected with its designated connection on the rear side of the gun control unit (see the operating manual of the gun control unit). The functions of the spray nozzles are described in the corresponding section of this manual.

## Flat jet nozzle with vented central electrode

The vented flat jet nozzle serves for the spraying and the charging of the powder. The powder is charged by the central electrode. The high voltage created in the gun cascade is guided through the center electrode.

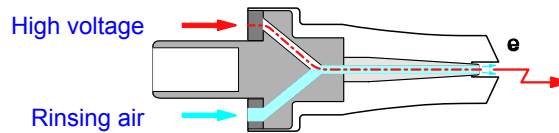

In order to prevent powder from sintering on the electrode, compressed air is used during the spray process.

The rinsing air adjustment on the gun control unit is described in the corresponding operating manual.

## Round jet nozzle with vented deflector and vented central electrode

The vented deflector is used, to give the powder stream emerging from the gun, a cloud formation. The powder is charged by the central electrode. The high voltage created in the gun cascade is guided through the center electrode.

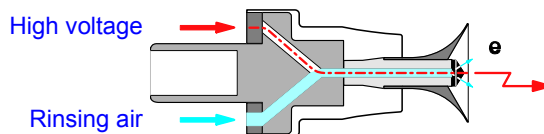

Since powder can accumulate on the baffle plate, it must be rinsed with compressed air.

The rinsing air adjustment on the gun control unit is described in the corresponding operating manual.

---

## Typical properties - Characteristics of the functions



### Remote control

- Adapt powder output (The powder output is correspondingly increased or reduced) - factory setting
- Program change (It is switching between programs P01-P20)
- Activate/stop PowerClean process (injector, powder house and guns are rinsed)



### Powder hose quick release connection

- Quick and simple connection and disconnection from powder hose and application cup



### Connection for SuperCorona Ring

- Quick and simple connection and disconnection of SuperCorona ring

# Start-up

---

## Preparation for start-up

### Basic conditions

When starting up the OptiFlex 2 GM03 powder control unit, the following general conditions impacting the coating results must be taken into consideration:

- Gun correctly connected
- Gun control unit correctly connected
- Corresponding power and compressed air supply available
- Powder preparation and powder quality

---

## Connecting the OptiFlex 2 GM03 manual powder gun

The OptiFlex 2 GM03 manual powder gun is delivered ready-to-use by the manufacturer. Just a few cables and hoses must be connected.



---

### NOTE!

**The compressed air must be free of oil and water!**

---

The gun is connected as follows:

1. Connect rinsing air hose and powder hose to gun
2. Lay out gun cable, rinsing air hose and powder hose and bind using Velcro strips (included)
3. Connect the gun cable plug to the socket **2.3** on the rear side of the control unit
4. Connect rinsing air hose to coupling **1.4**
5. Connect powder hose to injector

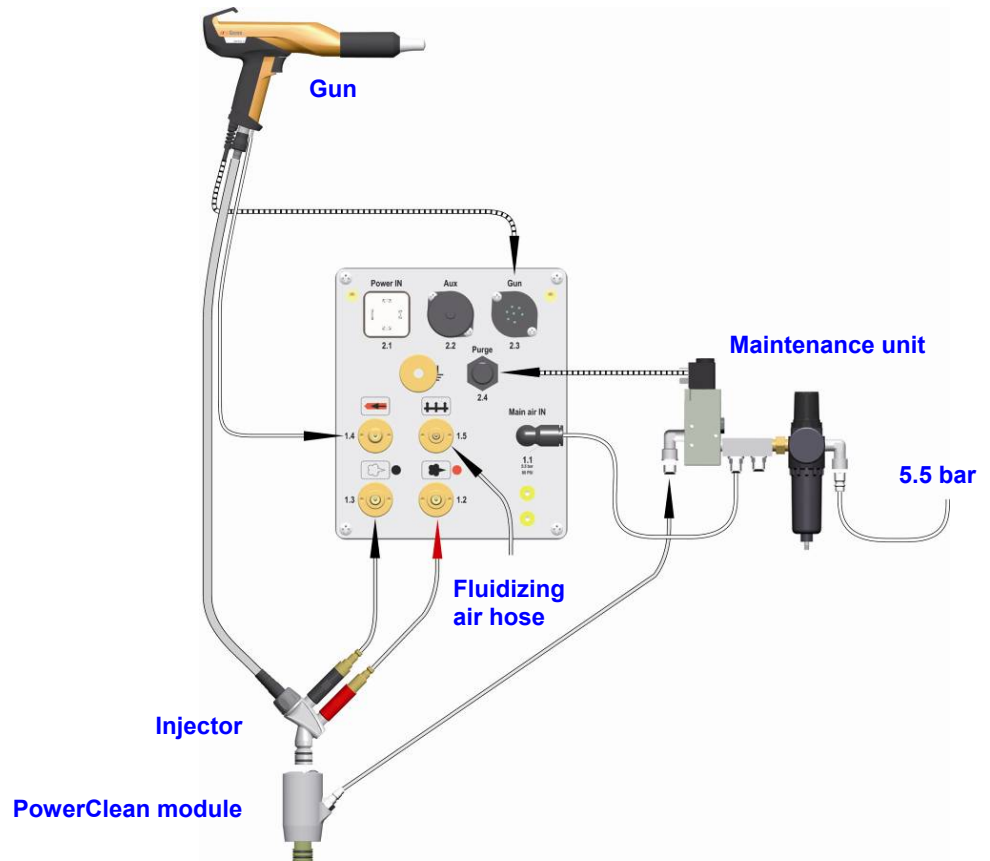

*Connection instructions - overview*

# Initial start-up

**NOTE!**

If a malfunction occurs, see the troubleshooting guide, as well as the gun control unit operating manual!

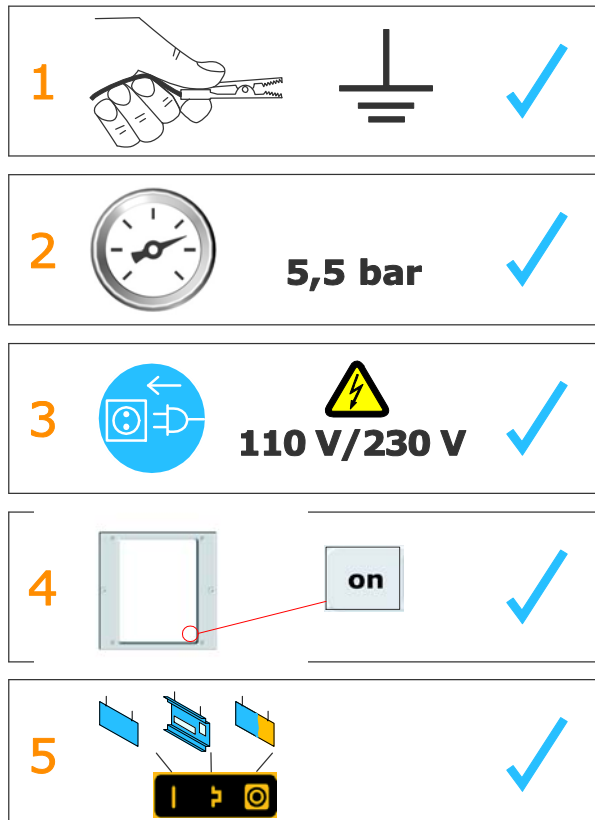
**NOTE!**

The remainder of the start-up procedure for the OptiFlex 2 GM03 manual powder gun is explicitly described in the operating instructions for the OptiFlex 2 CG09 manual powder gun control unit (chapter "Initial start-up" and "Daily start-up")!

## Operation

### Setting of total air



*correct powder cloud*



*too little total air*



**NOTE!**

A total air volume of 4 Nm<sup>3</sup>/h and a 50% powder share are recommended as the base values.

### Setting the powder quantity



*much powder*



*little powder*



**NOTE!**

To achieve maximum efficiency, we recommend avoided an overly high powder volume where possible!

### Setting the electrode rinsing air

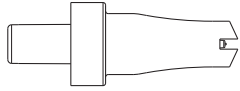

approx.  
0.1 Nm<sup>3</sup>/h

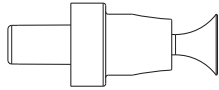

approx.  
0.5 Nm<sup>3</sup>/h

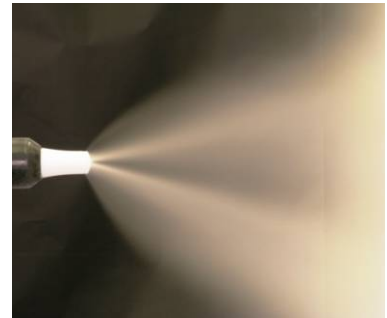

*too much electrode rinsing air*

## Activation of the PowerClean function

1. 
  - The LCD segments begin to move on the CG09 display



**NOTE!**  
The PowerClean function can be stopped as required using the P key.



2. 
  - 1 x**  
= automatically
  - 2 x**  
= manually

Procedure	Effect
<b>automatic</b>	<ul style="list-style-type: none"> <li>- The automatic rinsing process is started</li> <li>- Injector, powder hose, gun and spray nozzle are purged using compressed air</li> <li>- The automated PowerClean function enables parallel cleaning of other components, such as the fluid intake unit, powder container, etc.</li> </ul>
<b>manual</b>	<ul style="list-style-type: none"> <li>- The operator controls the number and length of the PowerClean impulse by pressing the pistol trigger a second time</li> </ul>

After completion of the PowerClean procedure, the controller switches back to coating mode.

## Activate/deactivate the program change via remote control

The remote control function has been set in the factory to change the powder output. If the operator prefers the possibility to switch between the programs P01-P20, this function is to be activated/deactivated on the control unit as follows:

1. Hold  key pressed
2. Press  key  
The program change function is activated/deactivated

# Cleaning and maintenance

**NOTE!**

Regular, careful cleaning and maintenance extends the service life of the OptiFlex 2 GM03 manual powder gun and ensures long-lasting, uniform coating quality!

The parts, which are to be replaced during maintenance work, are available as spare parts. These parts will be found in the corresponding spare parts list!

---

## Cleaning

### Cleaning the manual powder gun

**NOTE!**

Before cleaning the powder gun, switch off the control unit. The compressed air used for cleaning must be free of oil and water!

**Daily:**

1. Blow off the outside of the gun and wipe, clean etc.

**Weekly:**

2. Remove powder hose
3. Remove the spray nozzle from the gun and clean it with compressed air
4. Blow through the gun with compressed air, beginning from the connection in flow direction
5. Clean the integrated gun tube with the brush supplied, if necessary
6. Blow through the gun with compressed air again
7. Clean the powder hose
8. Reassemble the gun and connect it

**WARNING**

The following solvents may not be used to clean the OptiFlex 2 manual powder gun:

Ethylene chloride, acetone, ethyl acetate, methyl ethyl ketone, methylene chloride, premium gasoline, turpentine, tetrachloromethane, toluene, trichloroethylene, xylene!



---

**NOTE!**

**Only cleaning agents with a flash point of a least 5 Kelvin above the ambient temperature, or cleaning places with technical ventilation are allowed!**

---

## **Cleaning the spray nozzle**

### ***Daily or after every shift***

- Clean the inside and outside of the spray nozzle with compressed air.  
Never immerse the parts in solvents!
- Check the seating of the spray nozzles.



---

**WARNING**

**Make sure that the threaded sleeve is always tightened well. If the spray nozzle is just fitted loosely, there is danger of a flash-over of the gun high voltage, which can damage the gun!**

---

### ***Weekly:***

- Remove the spray nozzle and clean on the inside with compressed air. If sinterings should have formed, then they have to be removed!

### ***Monthly***

- Check spray nozzle for wear

The flat jet nozzle is to be replaced, if:

- the spray pattern is no longer a regular oval
- deeper grooves are in the nozzle slot, or even the wall thickness is no longer recognizable
- the wedge of the electrode holder is worn

Nozzles with deflectors:

- if the wedge of the electrode holder is worn down, then the electrode holder is to be replaced

---

## Maintenance

The OptiFlex 2 GM03 is designed to require only a minimum amount of maintenance.

1. Clean gun with dry cloth, see chapter "Maintenance"
2. Check connection points to powder house.
3. Replace the powder hoses, if necessary.

### Replacing parts

Except for the replacement of possible defective parts, there are very few repairs to be made.



---

#### **NOTE!**

**The replacement of the cascade and the repair of the powder gun cable connection is only permitted by an authorized ITW Gema Service center! Contact your ITW Gema representative for details!**

---



# Troubleshooting

## General information

Event	Causes	Corrective action
H11 (Help code on control unit)	Gun not connected	Connect the gun
	Gun plug or gun cable defective	Contact local Gema representative
	Remote control on powder gun defective	Contact local Gema representative
Gun LED remains dark, although the gun is triggered	High voltage adjustment is set too low	Increase high voltage
	Gun plug or gun cable defective	Contact local Gema representative
	LED on gun defective	Contact local Gema representative
Powder does not adhere to object, although the gun is triggered and sprays powder	High voltage and current deactivated	Check the high voltage and current setting
	High voltage cascade defective	Contact local Gema representative
	The objects are not properly grounded	Check the grounding
The gun does not spray powder, although the control unit is switched on and the gun trigger is pressed	Compressed air not present	Connect the equipment to the compressed air
	Injector or nozzle on the injector, powder hose or powder gun clogged	Clean the corresponding part
	Insert sleeve in the injector is clogged	Clean/replace
	No conveying air: - Throttle motor defective - Solenoid valve defective	Contact local Gema representative
	Front plate defective	Contact local Gema representative

Event	Causes	Corrective action
Gun achieving only poor spray profile	Total air incorrectly configured	Increase the powder quantity and/or total air volume on the control unit
	Bend or damage to air lines to injector	Check air lines to injector
	Insert sleeve in the injector worn or not inserted	Replace or insert it
	Fluidization not running	see above

# Spare parts list

---

## Ordering spare parts

When ordering spare parts for powder coating equipment, please indicate the following specifications:

- Type and serial number of your powder coating equipment
- Order number, quantity and description of each spare part

**Example:**

- **Type** OptiFlex 2 GM03  
**Serial number** 1234 5678
- Order no. 203 386, 1 piece, Clamp - Ø 18/15 mm

When ordering cable or hose material, the required length must also be given. The spare part numbers of this bulk stock is always marked with an \*.

Wearing parts are always marked with a #.

All dimensions of plastic hoses are specified with the external and internal diameter:

**Example:**

Ø 8/6 mm, 8 mm outside diameter (o/d) / 6 mm inside diameter (i/d)



---

**WARNING!**

**Only original ITW Gema spare parts should be used, because the explosion protection will also be preserved that way. The use of spare parts from other manufacturers will invalidate the ITW Gema guarantee conditions!**

---

## OptiFlex 2 GM03 manual powder gun - Spare parts list

### Remarks

1. If a part of the gun body should be broken, or the high voltage cascade in the gun body should be defective, then the whole gun body has to be sent in for repair!
2. If the powder gun cable is defective, it is to be completely sent in for repair!

<b>A</b>	OptiFlex 2 GM03 manual powder gun - complete <b>negative polarity</b> , incl. gun cable - 2 m, rinsing air hose - 6 m, flat jet nozzle, brush and parts kit, without powder hose	1008 070
	OptiFlex 2 GM03 manual powder gun - complete <b>positive polarity</b> , incl. gun cable - 6 m, rinsing air hose - 6 m, flat jet nozzle, brush and parts kit, without powder hose	1008 073
<b>B</b>	Manual powder gun shaft OptiFlex 2 GM03 (incl. cascade) with:	
	Gun cable 2 m, negative polarity (-)	1007 971
	Gun cable 6 m, negative polarity (-)	1007 972
	Gun cable 12 m, negative polarity (-)	1007 973
	Gun cable 2 m, positive polarity (+)	1007 974
	Gun cable 6 m, positive polarity (+)	1007 975
	Gun cable 12 m, positive polarity (+)	1007 968
1	Threaded sleeve - complete	1007 229#
2	Flat jet nozzle NF20 - complete	1007 931#
2.1	Electrode holder - complete	1007 683#
2.2	Flat jet nozzle NF20	1007 934#
	<b>Parts set (not shown), consisting of:</b>	<b>1002 359</b>
	Cleaning brush - Ø 12 mm	389 765
	Flat jet nozzle NF21	1007 935#
	Cable clamp	303 070
	Hose connector – complete, for hose interior Ø 11-12 mm	1001 340
	Powder hose - Ø 10 mm (not shown)	1001 673*#
	Powder hose - Ø 11 mm (not shown)	105 139*#

# Wearing part

---

## OptiFlex 2 GM03 manual powder gun - Spare parts list

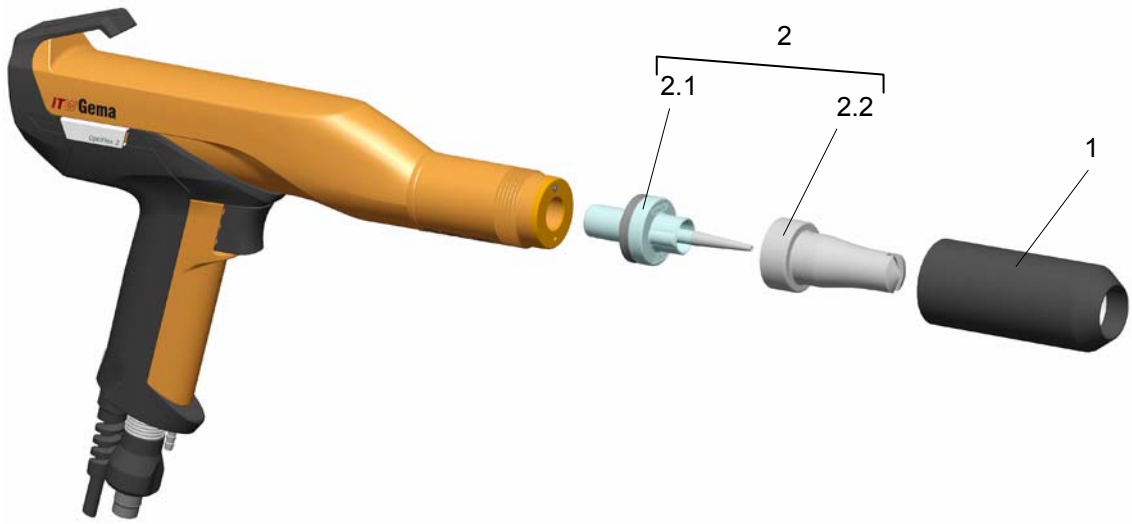

*OptiFlex 2 GM03 manual powder gun – spare parts list*

## PowerClean module

	PowerClean module - complete	1007 362
1	Elastomer valve	1000 089#
2	O ring - Ø 16x2 mm, anti-static	1007 794#
3	Fluidizing tube bearing	1007 356
4	Fluidizing tube	1007 355
5	Stop pins	1007 359
	# Wearing part	

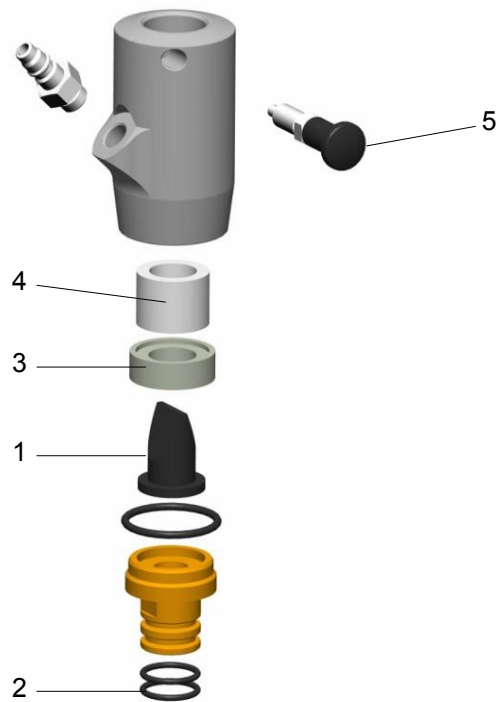

PowerClean module – Spare parts

---

## OptiFlex 2 GM03 manual powder gun - SuperCorona

1	SuperCorona PC05	1008 165#
2	SuperCorona PC06 – for extension 150 mm	1008 169#
3	SuperCorona PC06 – for extension 300 mm	1008 170#



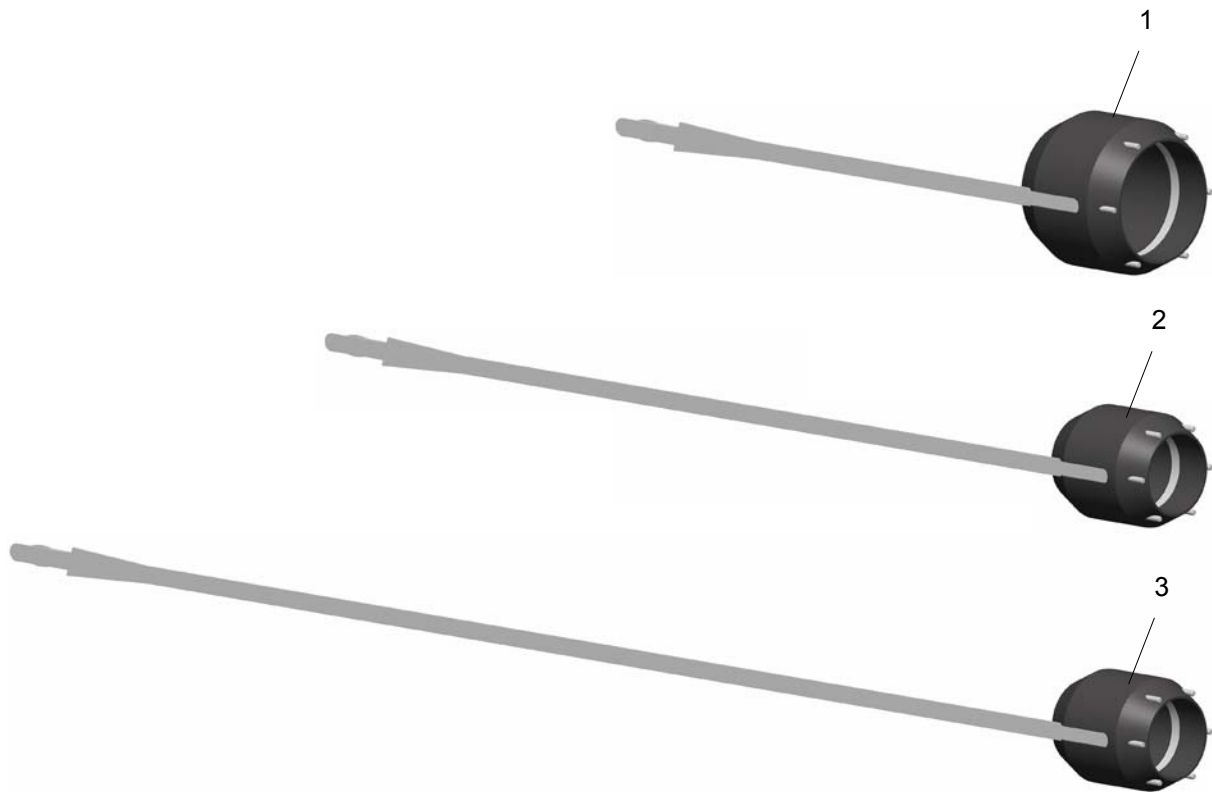





# Wearing part



*SuperCorona – spare parts*



## OptiFlex 2 GM03 manual powder gun - accessories

### OptiFlex 2 GM03 flat spray nozzles – overview (wearing parts)

Field of application	A	B	A + B	Threaded sleeve	Multi-spray adapter
Profiles/flat parts (standard nozzle)	 <b>NF20</b> 1007 934	 1007 683	NF20 1007 931	 1007 229	 1003 634*
	 <b>NF21</b> 1007 935		NF21 1007 932		
Large surfaces	 <b>NF24</b> 1008 147		NF24 1008 142	 1008 326	 1003 897*





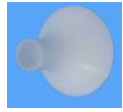

\* not type approved (ATEX)

## OptiFlex 2 GM03 rounded spray nozzles – overview (wearing parts)





Field of application	A	B	A + B	Threaded sleeve	Deflectors
Suitable for large surfaces	 <b>NS04</b> 1008 151	 1008 152	NS04 1008 150	 <b>1007 229</b>	
					Ø 16 mm 331 341
					Ø 24 mm 331 333
					Ø 32 mm 331 325
					Ø 50 mm 345 822

\* not type approved (ATEX)

**OptiFlex 2 GM03 gun extensions and SuperCorona**

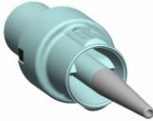
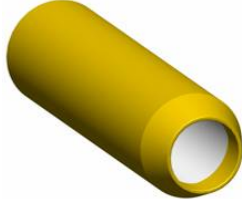
	Gun extensions		SuperCorona	
	L = 150 mm	L = 300 mm	for L = 150 mm	for L = 300 mm
Ø 27 mm ohne Düse	 1007 718	 1007 719	 1008 169	 1008 170
Ø 27 mm flat jet NF25	 1007 746	 1007 747		
Ø 27 mm with deflector Ø 24 mm	1007 748	1007 749		

### OptiFlex 2 GM03 spray nozzles for extensions – overview (wearing parts)

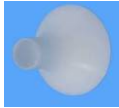

Field of application	A	B	A + B	Threaded sleeve	Multispray-Adapter Deflectors							
Profiles/flat parts	 <b>NF25</b> 1007 735	 1007 684	NF25 1007 743	 <b>1007 740</b>	--							
Complex profiles and depressions	 <b>NF26</b> 1007 742		NF26 1007 744		--							
Suitable for large surfaces	 <b>NS05</b> 1008 257	 1008 258	NS05 1008 259		 <table border="1"> <tr> <td>Ø 16 mm</td> <td>331 341</td> </tr> <tr> <td>Ø 24 mm</td> <td>331 333</td> </tr> <tr> <td>Ø 32 mm</td> <td>331 325</td> </tr> <tr> <td>Ø 50 mm</td> <td>345 822</td> </tr> </table>	Ø 16 mm	331 341	Ø 24 mm	331 333	Ø 32 mm	331 325	Ø 50 mm
Ø 16 mm	331 341											
Ø 24 mm	331 333											
Ø 32 mm	331 325											
Ø 50 mm	345 822											

\* not type approved (ATEX)

**Powder hoses - overview**

Powder hose	Field of application	Diameter	Parts No.	Material	Type	Remarks
 <p>                     Ø 12/ 18 mm Typ 75 Material POE                 </p> <p>                     Ø 11/ 16 mm Typ 66 Material POE                 </p> <p>                     Ø 10/ 15 mm Typ 74 Material POE                 </p>	Fast color switches	Ø 11/16 mm	<b>105 139</b>	POE	66	<b>antistatic</b>
	Fast color switches – low powder flow	Ø 10/15 mm	<b>1001 673</b>	POE	74	<b>antistatic</b>
	Fast color switches – High powder flow	Ø 12/18 mm	<b>1001 674</b>	POE	75	<b>antistatic</b>

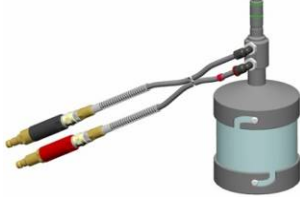
## Other accessories

<b>Application cup</b>	<p>150 ml</p>  <p>1004 552</p>	<p>500 ml</p>  <p>1002 069</p>
<b>Gun extension cables</b>	 <p>L=6 m 1002 161 L=14 m 1002 162</p>	
<b>Antistatic gloves (1 pair)</b>	 <p>800 254</p>	

